

T  ISLIGHTS



T  ISLIGHTS

Contact us:



Product Catalog

2025 —
www.twislights.com

About us

At TWISLIGHTS, we believe in transforming spaces with cutting-edge lighting solutions. We combine innovation, precision, and expertise to deliver unparalleled lighting experiences. With a strong legacy of excellence, we are committed to shaping the future of illumination with energy-efficient, sustainable, and high-performance lighting solutions.



Applications

- Commercial & Office Spaces
- Residential Spaces
- Industrial & Warehouse Lighting
- Architectural & Decorative Lighting
- Outdoor & Street Lighting



Experience

experience & network to be added

Research & Development

- **Energy Efficiency & Sustainability**
Creating eco-friendly solutions that minimize carbon footprints.
- **Smart & Adaptive Lighting**
Developing IoT-enabled systems for enhanced automation.
- **Aesthetic & Functional Design**
Merging style with functionality to elevate lighting experiences.



Channel Partners

Led Source



CITIZEN



Optics



Control Gear

T W I S L I G H T S



Smart Control

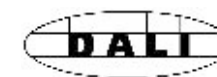

ANALOGUE DIMMING



Dimmable

CASAMBI





01 Delta 03	
02 Tepar 04	
03 Mini Spot 05-06	
04 Ringo 07-08	
05 Lotus 09-10	
06 Aqua 11-12	
07 Wally 13-14	
08 Faro 15-16	
09 Bella 17-18	
10 Beat 19-20	
11 Dome 21-22	
12 Poppy 23-24	

13 Linea 25-26	
14 Focus 29-30	
15 Duke 31-32	
16 Spotty 33-34	
17 Drum 35-36	
18 Strella 37-38	
19 Streak 39-40	
20 Bliss 41-42	
21 Blendy 43-44	
22 Ribbon 45-46	
23 Wallwasher 47-48	
24 Swimming Pool 49-50	

25 Profile 51-54	
------------------------	--

26 Go wireless 55-60	Wifi	BLE	Zigbee	Tuya Accessories
----------------------------	------	-----	--------	------------------

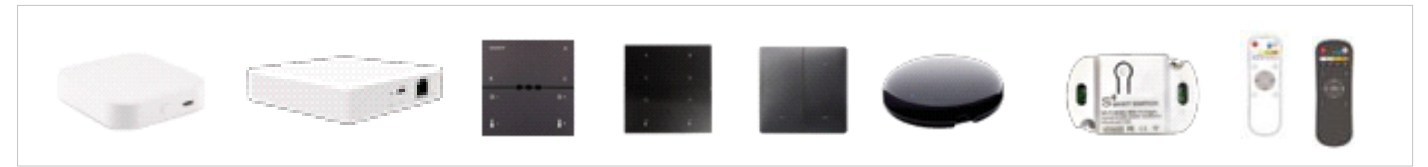

27 Twilight X Casambi 61-64



28 Twilight X Ltech 65-68



29 Surface 69	
---------------------	--

30 Recessed 69	
----------------------	--

31 CIRCULO900-SUSPENDED 70	
----------------------------------	--

32 DONUT900-SUSPENDED 70	
--------------------------------	--

32 T&N 71&72



Delta



TL 1143-8W



TL 1143-12W

FIXED DOWN LIGHT FIXED DOWN LIGHT

SPECIFICATIONS

MODEL NO.	POWER	DIMENSIONS (mm)	IP RATING	BODY COLOR
TL 1143	8 WATT	C60*H65*D68	20	White/Black
TL 1143	12 WATT	C75*H75*D85	20	White/Black
TL 1143	18 WATT	C86*H100*D95	20	White/Black

CCT	CRI	OPERATION	BEAM ANGLE	POWER FACTOR
3000K/4000K/5000K/TUNABLE	>80	(ON/OFF)/DALI/TRIAC	40°	>0.95

Optional [CRI 90 | Dimmable | Tunable White | Warm to Dim | Bluetooth]

Tepar



TL 3054



TL 3056

SPECIFICATIONS

MODEL NO.	POWER	PRODUCT SIZE	CUTOUT	BODY COLOR
TL 3054	7 WATT	70x55	65	White/Black
TL 3055	12 WATT	80x68	75	White/Black
TL 3056	18 WATT	90x80	85	White/Black

CCT	CRI	OPERATION	BEAM ANGLE
3000K/4000K/5000K/TUNABLE	>80	(ON/OFF)/DALI/TRIAC	36°

Optional [CRI 90 | Dimmable | Tunable White | Warm to Dim | Bluetooth]



MINI SPOT



TL 3030

TRIMLESS FLAT



TL 3031

FLAT



TL 3032

DEEP



TL 3033

OVAL

SPECIFICATIONS

MODEL NO.	POWER	DIMENSIONS (mm)	IP RATING	BODY COLOR
TL 3030	7.2 WATT	C80*H68*D80	44	Black
TL 3031	7.2 WATT	C45*H78 *D50	44	Black/ White
TL 3032	7.2 WATT	C45*H78*D50	44	Black
TL 3033	7.2 WATT	C45*H78*D50	44	Black/ White

CCT	CRI	OPERATION	BEAM ANGLE	POWER FACTOR
3000K/4000K/TW	>90	(ON/OFF)/DALI/TRIAC	30°	>0.95

Optional

- CRI 90
- Dimmable
- Tunable White
- Warm to Dim
- Bluetooth



RINGO



TL 3043

FIXED DOWN LIGHT

SPECIFICATIONS

MODEL NO.	POWER	DIMENSIONS (mm)	IP RATING	BODY COLOR
TL 3043	11.8 WATT	C55*H78*D64	54	White/Black

CCT	CRI	OPERATION	BEAM ANGLE	POWER FACTOR
3000K/4000K/6000K/TUNABLE	>90	(ON/OFF)/DALI/TRIAC	40°	>0.95





LOTUS



TL 3038

FIXED DOWN LIGHT

SPECIFICATIONS

MODEL NO.	POWER	DIMENSIONS (mm)	IP RATING	BODY COLOR
TL 3038	7 WATT	C60*H55*D70	20	White/Black
TL 3039	12 WATT	C75*H63* D85	20	White/Black
TL 3040	18 WATT	C85*H78*D100	20	White/Black

CCT	CRI	OPERATION	BEAM ANGLE	POWER FACTOR
3000K/4000K/5000K/TUNABLE	>90	(ON/OFF)/DALI/TRIAC	40°	>0.95

Optional [CRI 90 | Dimmable | Tunable White | Warm to Dim | Bluetooth]



AQUA



TL 3036

FIXED DOWN LIGHT



TL 3037

FIXED DOWN LIGHT

SPECIFICATIONS

MODEL NO.	POWER	DIMENSIONS (mm)	IP RATING	BODY COLOR
TL 3036	10 WATT	C52*H60*D58	20	White/Black
TL 3037	15 WATT	C60*H68*D66	20	White/Black

CCT	CRI	OPERATION	BEAM ANGLE	POWER FACTOR
3000K/4000K/5000K/TUNABLE	>90	(ON/OFF)/DALI/TRIAC	40°	>0.95

Optional [CRI 90 | Dimmable | Tunable White | Warm to Dim | Bluetooth]



WALLY



TL 3049

WALL WASHER

SPECIFICATIONS

MODEL NO.	POWER	DIMENSIONS (mm)	IP RATING	BODY COLOR
TL 3049	11.8 WATT	C60*H79*D72	54	White/Black

CCT	CRI	OPERATION	BEAM ANGLE	POWER FACTOR
3000K/4000K/6000K/TUNABLE	>90	(ON/OFF)/DALI/TRIAC	5°-38°	>0.95

- Optional [CRI 90 | Dimmable | Tunable White | Warm to Dim | Bluetooth]



FARO



TL 3041

FIXED DOWN LIGHT



TL 3042

FIXED DOWN LIGHT

SPECIFICATIONS

MODEL NO.	POWER	DIMENSIONS (mm)	IP RATING	BODY COLOR
TL 3041	8 WATT	C55*H70*D62	20	White/Black
TL 3042	15 WATT	C75*H77*D82	20	White/Black

CCT	CRI	OPERATION	BEAM ANGLE	POWER FACTOR
3000K/4000K/5000K/TUNABLE	>90	(ON/OFF)/DALI/TRIAC	40°	>0.95

Optional [CRI 90 | Dimmable | Tunable White | Warm to Dim | Bluetooth]



BELLA



FIXED DOWN LIGHT



TRIMLESS DOWN LIGHT

SPECIFICATIONS

MODEL NO.	POWER	DIMENSIONS (mm)	IP RATING	BODY COLOR
TL 3044	7 WATT	C62*H73*D68	44	White/Black
TL 3045	12 WATT	C72*H83*D78	44	White/Black
TL 3046	7 WATT	C65*H73*D100	44	White
TL 3047	12 WATT	C72*H83*D100	44	White

CCT	CRI	OPERATION	BEAM ANGLE	POWER FACTOR
3000K/4000K/5000K/tunable	>90	(ON/OFF)/DALI/TRIAC	36°	>0.95





TL 2555



TL 2556

SPECIFICATIONS

MODEL NO.	POWER	DIAMETER	HEIGHT	CUTOUT	BODY COLOR
TL 3054	5 WATT	62	25	55	White/Black
TL 3055	10 WATT	83	31	75	White/Black

CCT	CRI	OPERATION	BEAM ANGLE
3000K/4000K/6000K/TUNABLE	>80	(ON/OFF)/DALI/TRIAC	24°

Optional [CRI 90 | Dimmable | Tunable White | Warm to Dim | Bluetooth]



DOME



TL 3050

SCOOP LIGHT

SPECIFICATIONS

MODEL NO.	POWER	DIMENSIONS (mm)	IP RATING	BODY COLOR
TL 3050	6 WATT	C55* H42*D63	20	White/Black

CCT	CRI	OPERATION	BEAM ANGLE	POWER FACTOR
3000K/4000K/6000K	>90	(ON/OFF)/DALI/TRIAC	24°	>0.95

Optional [CRI 90 | Dimmable | Tunable White | Warm to Dim | Bluetooth]



POPPY



ADJUSTABLE SCOOP LIGHT

SPECIFICATIONS

MODEL NO.	POWER	DIMENSIONS (mm)	IP RATING	BODY COLOR
TL 3051	8 WATT	C65*H100*D72	20	White/Black

CCT	CRI	OPERATION	BEAM ANGLE	POWER FACTOR
3000K/4000K/6000K	>90	(ON/OFF)/DALI/TRIAC	38°	>0.95

Optional

- CRI 90
- Dimmable
- Tunable White
- Warm to Dim
- Bluetooth



LINEA



TL 1413

ROUND PIN LASER



TL 1414

ROUND PIN LASER



TL 1415

ROUND PIN LASER

SPECIFICATIONS

MODEL NO.	POWER	DIMENSIONS (mm)	IP RATING	BODY COLOR
TL 1413	6 WATT	C85X35*H32*D95X45	20	White/Black
TL 1414	12 WATT	C139X37*H32M*D148X45	20	White/Black
TL 1415	20 WATT	C272X37*H32*D282X45	20	White/Black

CCT	CRI	OPERATION	BEAM ANGLE	POWER FACTOR
3000K/4000K/6000K	>90	(ON/OFF)/DALI/TRIAC	36°	>0.95

Optional [CRI 90 | Dimmable | Tunable White | Warm to Dim | Bluetooth]



FOCUS



TL 1337

TRACK LIGHT



TL 1338

TRACK LIGHT



TL 1339

TRACK LIGHT



TL 1340

TRACK LIGHT

SPECIFICATIONS

MODEL NO.	POWER	DIMENSIONS (mm)	IP RATING	BODY COLOR
TL 1337	7 WATT	H135*D50	20	White/Black
TL 1338	15 WATT	H150*D60	20	White/Black
TL 1339	25 WATT	H180*D80	20	White/Black
TL 1340	35 WATT	H195*D80	20	White/Black

CCT	CRI	OPERATION	BEAM ANGLE	POWER FACTOR
3000K/4000K/6000K	>90	(ON/OFF)/DALI/TRIAC	60°	>0.95

Optional [CRI 90 | Dimmable | Tunable White | Warm to Dim | Bluetooth]



DUKE

Duke



TL 3052

GIMBLE DOWNLIGHT



TL 3053

GIMBLE DOWNLIGHT

SPECIFICATIONS

MODEL NO.	POWER	DIMENSIONS (mm)	IP RATING	BODY COLOR
TL 3052	2 WATT	C52*H60*D58	20	White/Black
TL 3053	2X7 WATT	C60*H68*D66	20	White/Black

CCT	CRI	OPERATION	BEAM ANGLE	POWER FACTOR
3000K/4000K/6000K	>90	(ON/OFF)/DALI/TRIAC	40°	>0.95

Optional

- CRI 90
- Dimmable
- Tunable White
- Warm to Dim
- Bluetooth



SPOTTY



TL 1337-S

SURFACE SPOT

SPECIFICATIONS

MODEL NO.	POWER	DIMENSIONS (mm)	IP RATING	BODY COLOR
TL 1337-S	7 WATT	H135*D50	20	White/Black
TL 1340-S	15 WATT	H150*D60	20	White/Black

CCT	CRI	OPERATION	BEAM ANGLE	POWER FACTOR
3000K/4000K/6000K/TUNABLE	>90	(ON/OFF)/DALI/TRIAC	40°	>0.95

Optional [CRI 90 | Dimmable | Tunable White | Warm to Dim | Bluetooth]



DRUM

Drum



TL 1190

SMD SURFACE DRUM LIGHT



TL 1191

SMD SURFACE DRUM LIGHT

SPECIFICATIONS

MODEL NO.	POWER	DIMENSIONS (mm)	IP RATING	BODY COLOR
TL 1190	12 WATT	H65*D90	20	White/Black
TL 1191	18 WATT	H60*D120	20	White/Black

CCT	CRI	OPERATION	BEAM ANGLE	POWER FACTOR
3000K/4000K/6000K	>90	(ON/OFF)	120°	>0.95

Optional [CRI 90 | Dimmable | Tunable White | Warm to Dim | Bluetooth]



TL 2354

RIMLESS SURFACE PANEL



TL 2355

RIMLESS SURFACE PANEL



TL 2356

RIMLESS SURFACE PANEL

SPECIFICATIONS

MODEL NO.	POWER	DIMENSIONS (mm)	IP RATING	BODY COLOR
TL 2 354	12 WATT	D: 140 H:50	20	White/Black
TL 2355	18 WATT	D: 140 H:50	20	White/Black
TL 2356	24 WATT	D: 170 H:50	20	White/Black

CCT	CRI	OPERATION	BEAM ANGLE	POWER FACTOR
3000K/4000K/6000K	>90	(ON/OFF)	120°	>0.95

Optional [CRI 90 | Dimmable | Tunable White | Warm to Dim | Bluetooth]



STREAK

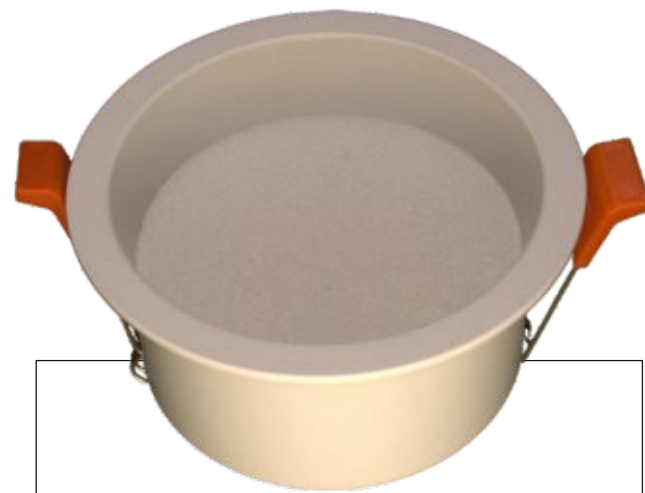

TL 2251

SMD DEEP DOWNLIGHT

SPECIFICATIONS

MODEL NO.	POWER	DIMENSIONS (mm)	IP RATING	BODY COLOR
TL 2251	12 WATT	C76*H47*D86	20	White/Black
TL 2252	18 WATT	C90*H50*D105	20	White/Black
TL 2253	22 WATT	C120*H60*D130	20	White/Black

CCT	CRI	OPERATION	BEAM ANGLE	POWER FACTOR
3000K/4000K/6000K/TUNABLE	>90	(ON/OFF)/DALI/TRIAC	60°	>0.95

Optional [CRI 90 | Dimmable | Tunable White | Warm to Dim | Bluetooth]



TL 1145-7W
SURFACE COB CYLINDER

SPECIFICATIONS

MODEL NO.	POWER	DIMENSIONS (mm)	IP RATING	BODY COLOR
TL 1145-7W	7 WATT	D: 50 H:82	20	White/Black
TL 1145-18W	12 WATT	D: 70 H:100	20	White/Black
TL 1145-18W	18 WATT	D: 90 H:120	20	White/Black

CCT	CRI	OPERATION	BEAM ANGLE	POWER FACTOR
3000K/4000K/6000K	>90	(ON/OFF)	35°	>0.95

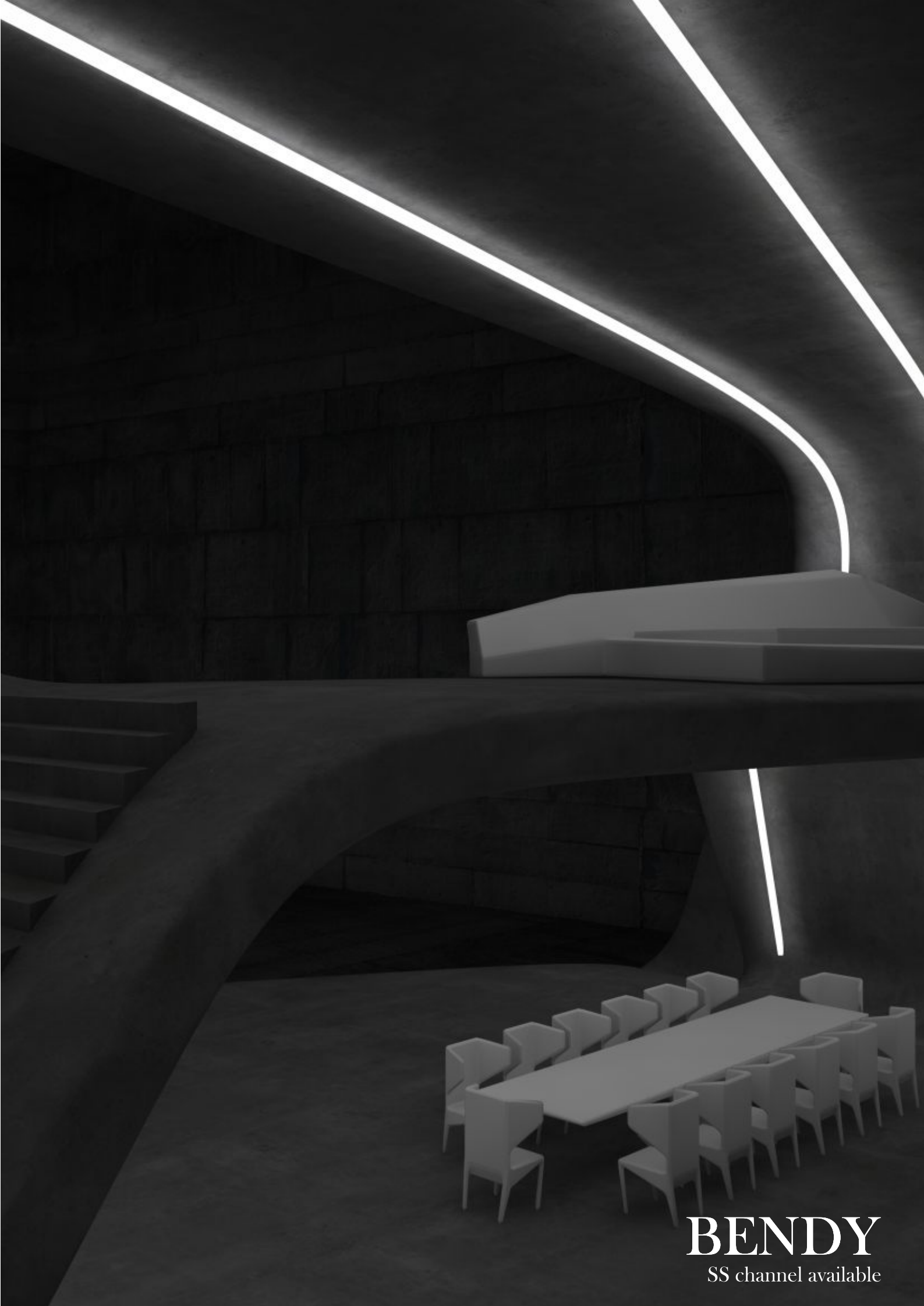

PRODUCT		MODEL NO.	POWER	BODY COLOR
		TLF 501S	12 WATT/mtr	White/Black
		TLF 502S	12 WATT/mtr	White/Black
		TLF 503S	12 WATT/mtr	White/Black
		TLF 504S	20 WATT/mtr	White/Black
		TLF 505T	12 WATT/mtr	White/Black
		TLF 506T	12 WATT/mtr	White/Black



TL 5057

INDOOR STRIP



TL 5054

INDOOR STRIP

SPECIFICATIONS

MODEL NO.	POWER	DIMENSIONS (mm)	IP RATING
TL 5057	12 WATT/mtr	5 mm	20
TL 5054	24 WATT/mtr	10 mm	20

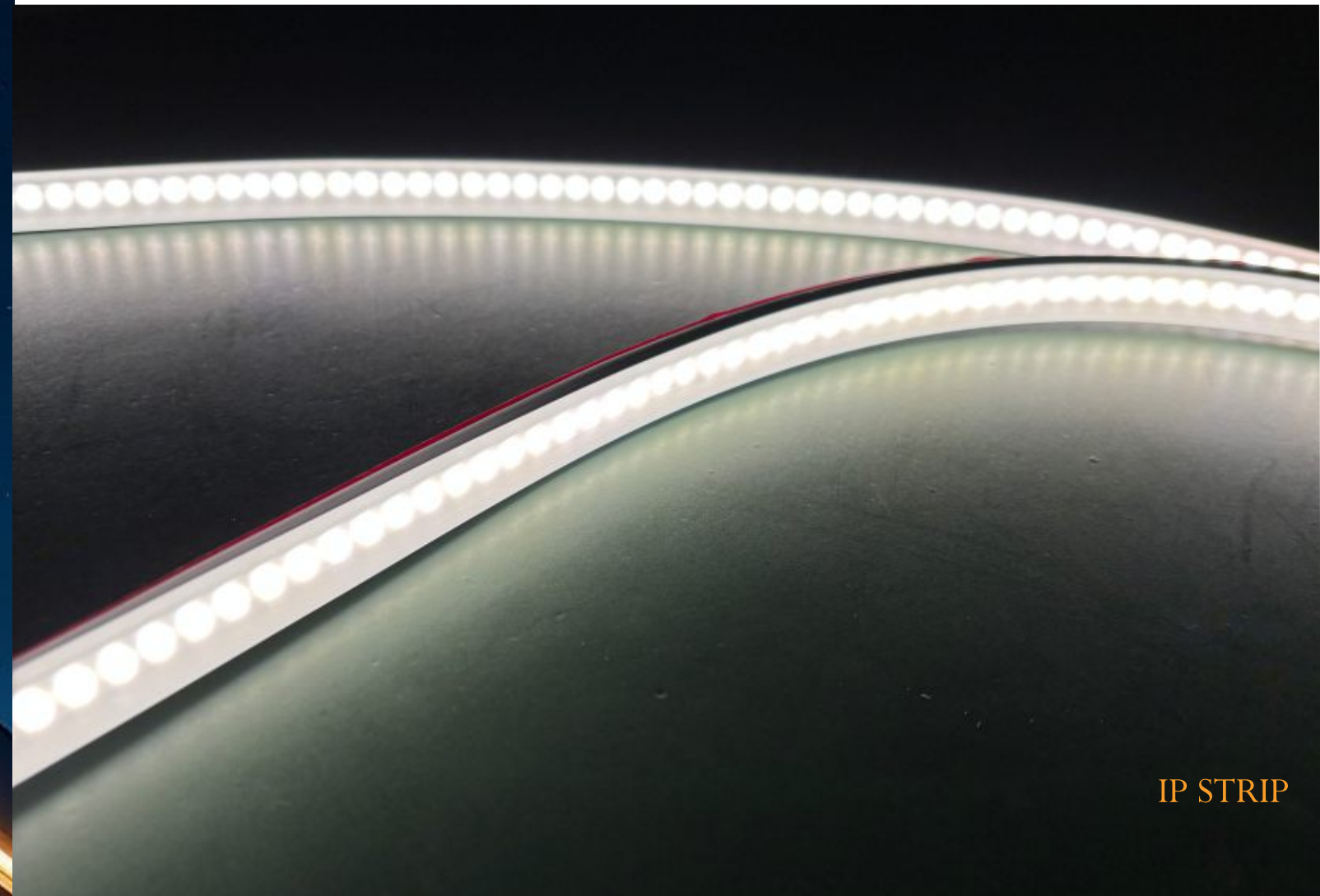
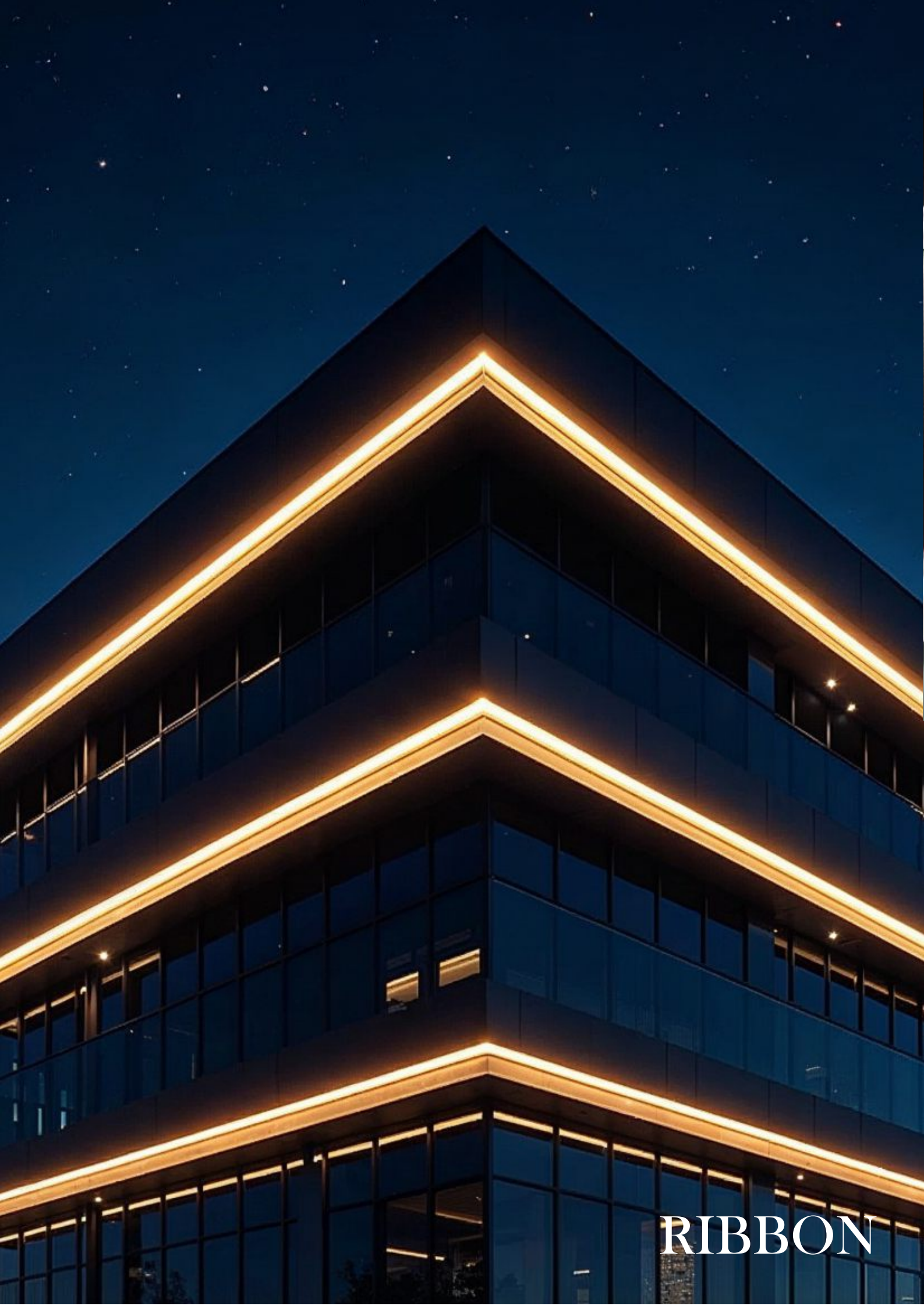

IP STRIP

SPECIFICATIONS

MODEL NO.	POWER	DIMENSIONS (mm)	IP RATING	CRI
TL WF 5057	9.6 WATT/mtr	12×5×5000 mm	67	90+
TL WF 5054	14.4 WATT/mtr	12×5×5000 mm	67	90+



TL WF End cap pair



TL WF Mounting clamp

RIBBON



WALL WASHER



TL 3D WASHER

ACCESSORIES



TL 3D PRF Clamp



TL 3D - STC



TL 3D ADJ.Clamp



TL 3D - WEC



TL 3D-CC

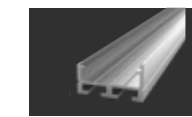

TL 3d 1200

SPECIFICATIONS

MODEL NO.	POWER	CCT	CRI	IP RATING	BEAM ANGLE
TL 3D	19.68W/Mtr.	3000K,3500K,4000K	90+	IP 67	10°

Optional [CRI 90 | Dimmable | Tunable White | Warm to Dim | Bluetooth]



SWIMMING POOL

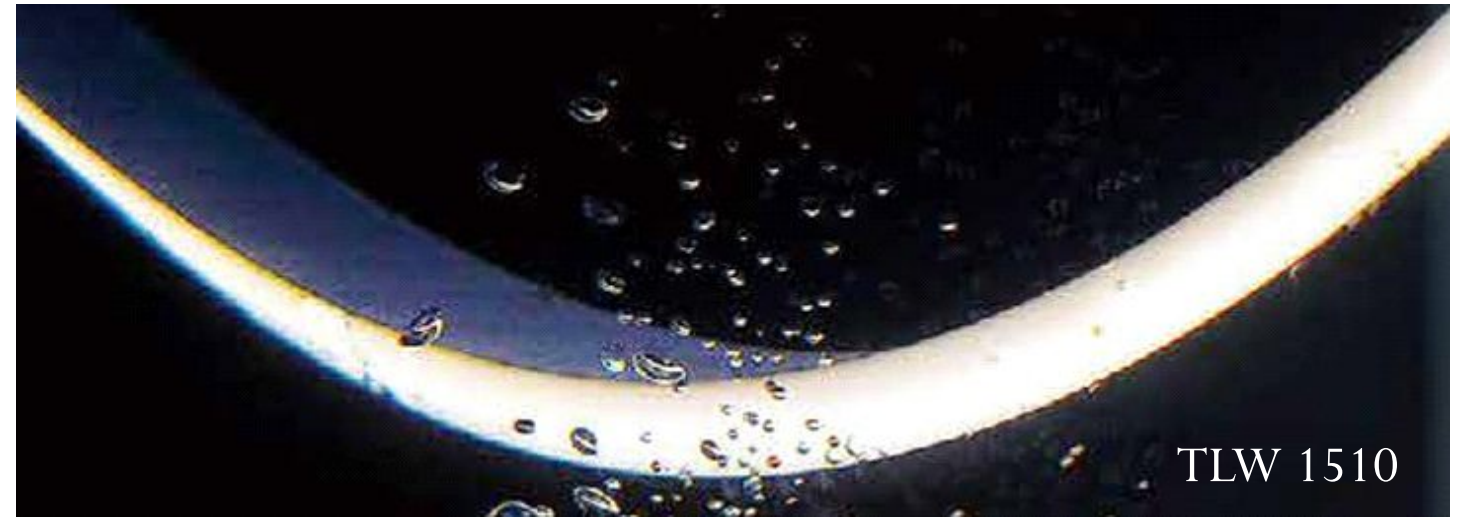

MOUNTING ACCESSORIES

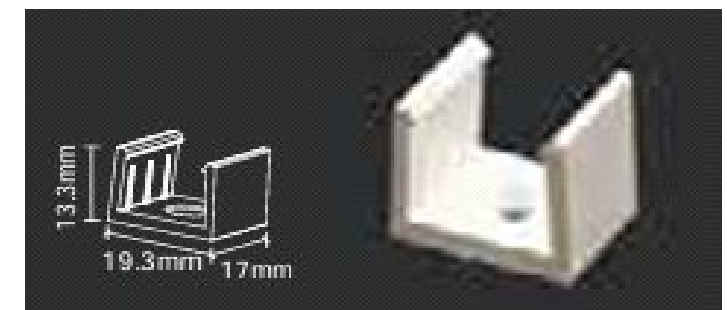
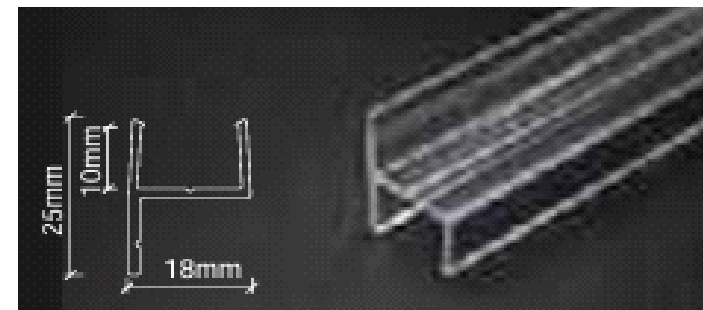

SPECIFICATIONS

MODEL NO.	POWER	DIMENSIONS (mm)	IP RATING	BODY COLOR
TLW 1510	10W/Mtr	15X10 mm	IP68 (2Mtr DEEP Max.)	

CCT	CRI	OPERATION	BEAM ANGLE
2700K,3000K,BLUE	90+	(ON/OFF)/DALI/TRIAC	-

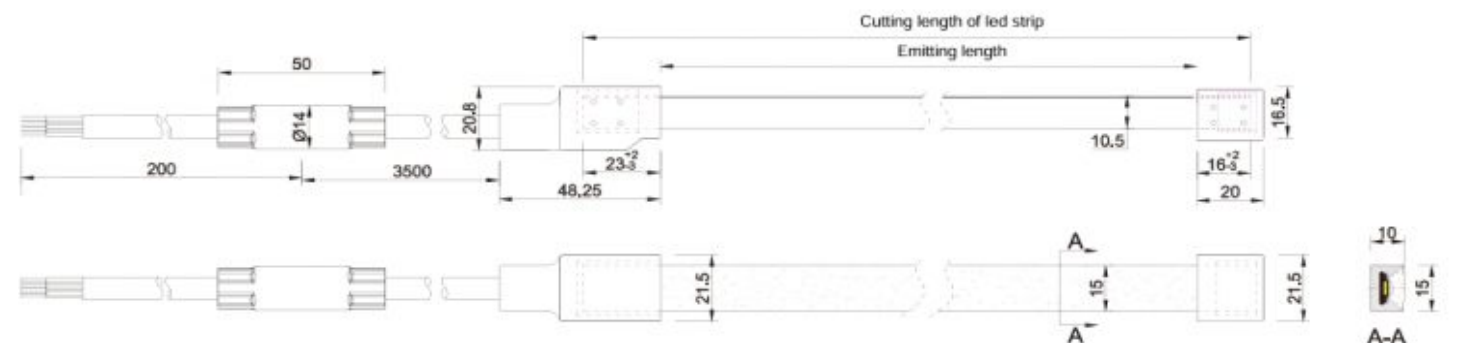

ORDER DC CONSTANT VOLTAGE POWER SUPPLY SEPERATELY.
POWER SUPPLY SHOULD BE MOUNT OUTSIDE WATER.



		<p>TLP 1707 17mm SURFACE 24 w/mtr</p>
		<p>TLP 2207 17mm CONCEAL 24 w/mtr</p>
		<p>TLP 945 LENS CURTAIN GRAZOR 30° 24 w/mtr</p>
		<p>TLP 946 15mm FURNITURE PROFILE 12 w/mtr</p>
		<p>TLP 5070 50X70 BUILT IN FLAT Photoshoot to be done 48+24W/mtr Prismatic diffuser available</p>
		<p>TLP 5080 50X80 DEEP 48+24W/mtr Prismatic diffuser available</p>

PROFILE



Profile

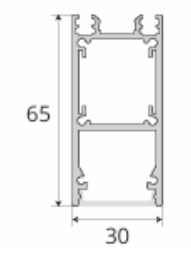

TLP 3570
48 w/mtr
35X70
BUILT IN FLAT
3600mm MAX

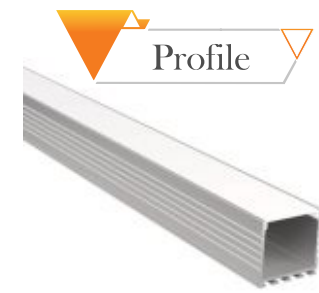

Profile

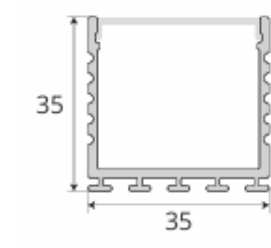

TLP 3535
48 w/mtr
35X35
SURFACE PROFILE
2400mm/3600mm

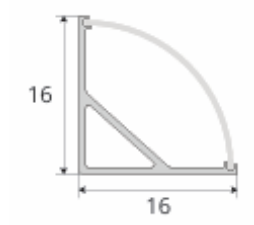

TLP CORNER
48 w/mtr
16X16mm
CORNER PROFILE
2000mm/3000mm

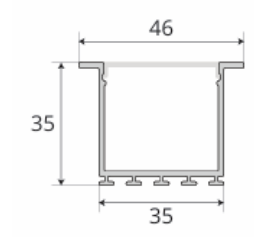

TLP 4535
48 w/mtr
35X35
CONCEAL PROFILE
2400mm/3600mm

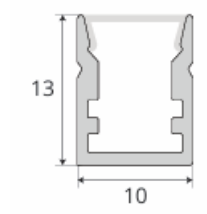

TLP 1012
48 w/mtr
10X12
SURFACE PROFILE
2000mm/3000mm

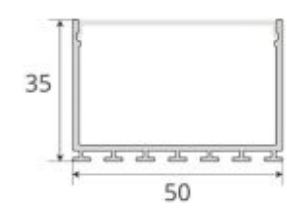

TLP 5035
48 w/mtr
50X35
SURFACE PROFILE
2400mm/3600mm

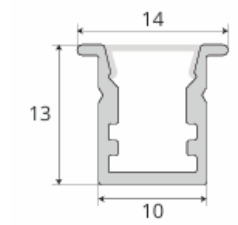

TLP 1412
48 w/mtr
10X12
CONCEAL PROFILE
2000mm/3000mm

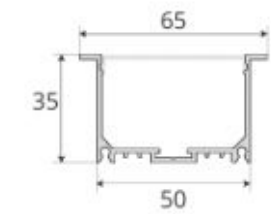

TLP 6535
48 w/mtr
50X35
CONCEAL PROFILE
2400mm/3600mm

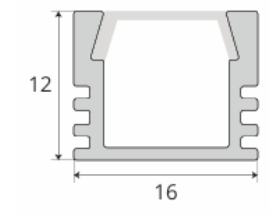

TLP 1612
24 w/mtr
16X12
SURFACE PROFILE
3000mm

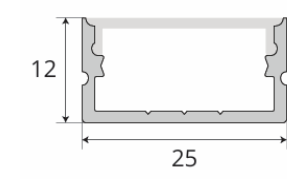

TLP 2512
24 w/mtr
35X70
BUILT IN FLAT
3600mm MAX

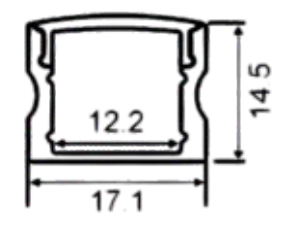

TLP 1714
24 w/mtr
17X14
SURFACE PROFILE
3000mm

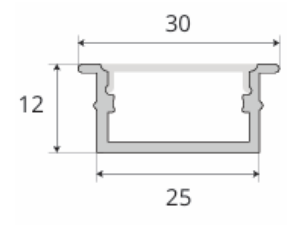

TLP 3012
24 w/mtr
25X12
CONCEAL PROFILE
2000mm/3000mm

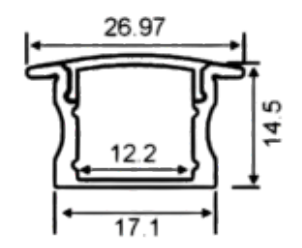

TLP 2214
24 w/mtr
17X14
CONCEAL PROFILE
2000mm

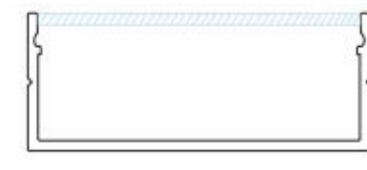

TLP 5012
24 w/mtr
50X12
SURFACE PROFILE
3000mm

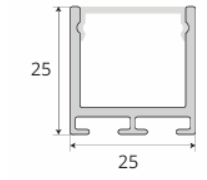

TLP 2525
24 w/mtr
25X25
SURFACE PROFILE
3600mm MAX

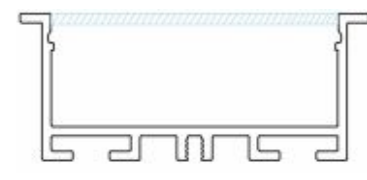

TLP 6512
24 w/mtr
50X12
CONCEAL PROFILE
3000mm



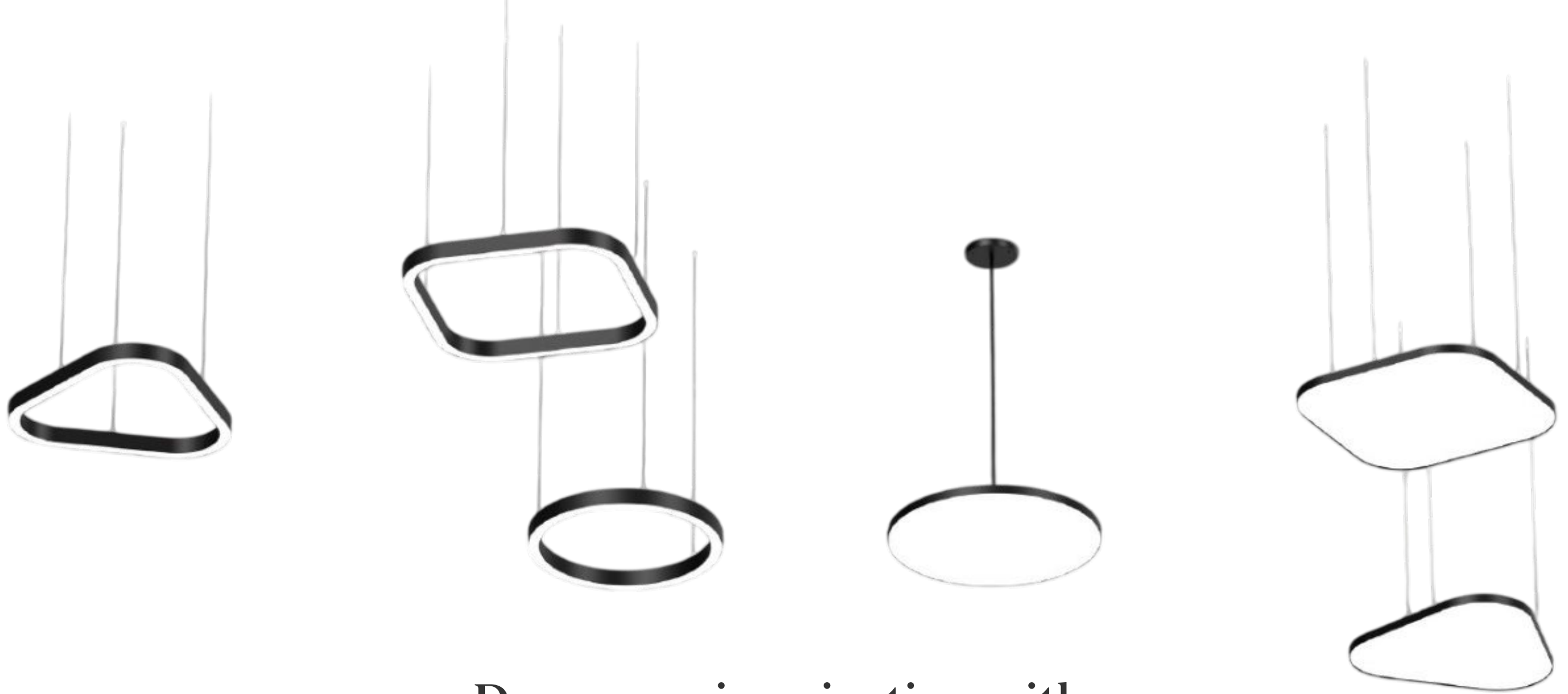

**Draw your imagination with
multiple color options and endless possibilities**

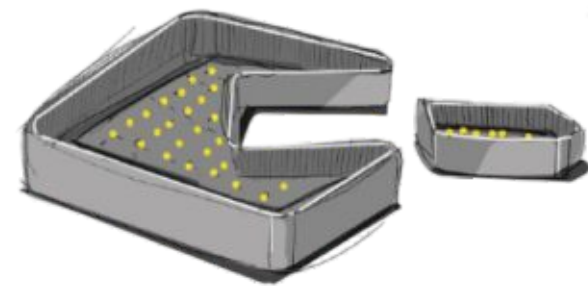



SPECIFICATIONS

SR NO.	PRODUCT SIZE	CODE	POWER	HEIGHT
1	300mm	Drum 300S	20W	70
2	450mm	Drum 450S	30W	70
3	600mm	Drum 600S	40W	70



SPECIFICATIONS

SR NO.	PRODUCT SIZE	CODE	POWER	HEIGHT
1	300mm	Drum 300S	20W	70
2	450mm	Drum 450S	30W	70
3	600mm	Drum 600S	40W	70



SPECIFICATIONS

SR NO.	PRODUCT SIZE	CODE	POWER	HEIGHT	WEIGHT
1	300mm	Drum 300S	20W	75	50
2	450mm	Drum 450S	30W	75	50
3	600mm	Drum 600S	40W	75	50
4	900mm	Drum 900S	60W	75	50



SPECIFICATIONS

SR NO.	PRODUCT SIZE	CODE	POWER	HEIGHT	WEIGHT
1	300mm	Drum 300S	20W	50	50
2	450mm	Drum 450S	30W	50	50
3	600mm	Drum 600S	40W	50	50
4	900mm	Drum 900S	60W	50	50





GO WIRELESS
Wifi/BLE/Zigbee/Tuya Drivers-cc



Dimensions (LXWXH) 123mm X 37mm X 22mm



Dimensions (LXWXH) 145mm x 35mm x 25mm



Dimensions (LXWXH) 103.5mm X 67.5mm X 30mm



Dimensions (LXWXH) 125mm x 13.5mm x 10mm



Dimensions (LXWXH) 62.25mm x 13.5mm x 11.5mm

SMART LIGHTING DRIVERS WIFI

MODEL NO	WATTAGE	CURRENT	VOLTAGE
CCD-15-350-1-WFT	6-15W -1CH WFT	(200, 250, 300, 350)mA	(30-42)Vdc
CCD-15-350-2-WFT	6-15W -2CH WFT	(200, 250, 300, 350)mA	(30-42)Vdc
CCD-24-600-1-WFT	6W-24W -1CH WFT	(300, 400, 500, 600)mA	(9-18)Vdc,
CCD-24-600-2-WFT	6W-24W -2CH WFT	(300, 400, 500, 600)mA	(9-18)Vdc
CCD-40-1000-1-WFT	24W-40W ACDC 1CH	(700, 800, 900, 1000)mA	(30-40)Vdc,
CCD-40-1000-2-WFT	24W-40W ACDC 2CH	(700, 800, 900, 1000)mA	(30-40)Vdc,

WIFI CONSTANT VOLTAGE DRIVERS
5A=60W(12V), 120W(24V), 10A=120W(12V), 240W(24V)

MODEL NO	WATTAGE	CURRENT	VOLTAGE
TL SLC-5-1-WFT	1CH 5A TW	5A	12Vdc=60W 24Vdc=120W
TL SLC-5-2-WFT	2CH 5A TW	5A	12Vdc=60W 24Vdc=120W
TL SLC-5-3-WFT	3CH 5A (RGB)	5A	12Vdc=60W 24Vdc=120W
TL SLC-5-5-WFT	5CH 5A,RGB+CW,(RGB+CCT)	5A	12Vdc=60W 24Vdc=120W
TL SLC-10-1-WFT	1CH 10A TW	10A	12Vdc=120W 24Vdc=240W
TL SLC-10-2-WFT	2CH 10A TW	10A	12Vdc=120W 24Vdc=240W
TL SLC-10-3-WFT	3CH 10A (RGB)	10A	12Vdc=120W 24Vdc=240W
TL SLC-10-5-WFT	5CH 10A,RGB+CW,(RGB+CCT)	10A	12Vdc=120W 24Vdc=240W

SMART LIGHTING DRIVERS BLE MESH

MODEL NO	WATTAGE	CURRENT	VOLTAGE
CCD-15-350-1PRO SMT	6-15W CVCC 1CH PRO SMT	(200, 250, 300, 350)mA	(30-42)Vdc
CCD-15-350-2 PRO SMT	6-15W CVCC 2CH PRO SMT	(200, 250, 300, 350)mA	(30-42)Vdc
CCD-24-600-1 PRO SMT	6-15W CVCC 1CH PRO SMT	(200, 250, 300, 350)mA	(30-42)Vdc
CCD-24-600-2 PRO SMT	6W-24W CVCC 1CH PRO SMT	(200, 250, 300, 350)mA	(30-42)Vdc
CCD-40-1000-1 SMT	24W-40W AC DC 1CH	(200, 250, 300, 350)mA	(30-42)Vdc
CCD-40-1000-2 SMT	24W-40W AC DC 2CH	(200, 250, 300, 350)mA	(30-42)Vdc

MESH CONSTANT VOLTAGE DRIVERS
5A=60W(12V), 120W(24V), 10A=120W(12V), 240W(24V)

MODEL NO	WATTAGE	CURRENT	VOLTAGE
TL SLC-5-1-SMT	1CH 5A TW	5A	12Vdc=60W 24Vdc=120W
TL SLC-5-2-SMT	2CH 5A TW	5A	12Vdc=60W 24Vdc=120W
TL SLC-5-3-SMT	3CH 5A (RGB)	5A	12Vdc=60W 24Vdc=120W
TL SLC-5-5-SMT	5CH 5A , RGB+CW,(RGB+CCT)	5A	12Vdc=60W 24Vdc=120W
TL SLC-10-1-SMT	1 CH 10A TW	10A	12Vdc=120W 24Vdc=240W
TL SLC-10-2-SMT	2 CH 10A TW	10A	12Vdc=120W 24Vdc=240W
TL SLC-10-3-SMT	3CH 10A (RGB)T	10A	12Vdc=120W 24Vdc=240W
TL SLC-10-5-SMT	5CH 10A, RGB+CW (RGB+CCT)	10A	12Vdc=120W 24Vdc=240W

SMART MAGTRACK DRIVERS-LONG

MODEL NO	WATTAGE	CURRENT	VOLTAGE
TL LV-2035-1-SMT	MAGTRACK - 1CH	(200, 250, 300, 350)mA	(22-40)Vdc
TL LV-3570-1-SMT	MAGTRACK - 1CH	(200, 250, 300, 350)mA	(22-40)Vdc
TL LV-2035-2-SMT	MAGTRACK - 2CH	(200, 250, 300, 350)mA	(22-40)Vdc
TL LV-3570-2-SMT	MAGTRACK - 2CH	(350, 450, 600, 700)mA	(22-40)Vdc

SMART MAGTRACK DRIVERS-MINI

MODEL NO	WATTAGE	CURRENT	VOLTAGE
TL MT-350-1-SMT	MINI MAGTRACK 1CH	(150,200,250,300)mA	48V=(20-42)Vdc 24V=(6-20)Vdc
TL MT-350-2-SMT	MINI MAGTRACK 2CH	(150,200,250,300)mA	48V=(20-42)Vdc 24V=(6-20)Vdc
TL MT-350-1-SMT	MINI MAGTRACK 1CH	(350, 450, 600, 700)mA	48V=(20-42)Vdc 24V=(6-20)Vdc
TL MT-350-2-SMT	MINI MAGTRACK 2CH	(350, 450, 600, 700)mA	48V=(20-42)Vdc 24V=(6-20)Vdc

APPLICATIONS: Downlight, Home, Off ice | AREAS OF APPLICATIONS: Home, Off ice | FEATURES: App Control, Zigbee, Bluetooth Mesh, Google Assistant, Amazon Alexa, Tunable White, Dimming

SMART LIGHTING DRIVERS ZIGBEE			
MODEL NO	WATTAGE	CURRENT	VOLTAGE
CCD-15-350-1PRO ZBT	6-15W CVCC 1CH PRO SMT	(200, 250, 300, 350)mA	(30-42)Vdc
CCD-15-350-2 PRO ZBT	6-15W CVCC 2CH PRO SMT	(200, 250, 300, 350)mA	(30-42)Vdc
CCD-24-600-1 PRO ZBT	6-15W CVCC 1CH PRO SMT	(200, 250, 300, 350)mA	(30-42)Vdc
CCD-24-600-2 PRO ZBT	6W-24W CVCC 1CH PRO SMT	(200, 250, 300, 350)mA	(30-42)Vdc
CCD-40-1000-1 ZBT	24W-40W AC DC 1CH	(200, 250, 300, 350)mA	(30-42)Vdc
CCD-40-1000-2 ZBT	24W-40W AC DC 2CH	(200, 250, 300, 350)mA	(30-42)Vdc

ZIGBEE CONSTANT VOLTAGE DRIVERS 5A=60W(12V), 120W(24V), 10A=120W(12V), 240W(24V)			
MODEL NO	WATTAGE	CURRENT	VOLTAGE
TL SLC-5-1-ZBT	1CH 5A TW	5A	12Vdc=60W 24Vdc=120W
TL SLC-5-2-ZBT	2CH 5A TW	5A	12Vdc=60W 24Vdc=120W
TL SLC-5-3-ZBT	3CH 5A (RGB)	5A	12Vdc=60W 24Vdc=120W
TL SLC-5-5-ZBT	5CH 5A , RGB+CW,(RGB+CCT)	5A	12Vdc=60W 24Vdc=120W
TL SLC-10-1-ZBT	1 CH 10A TW	10A	12Vdc=120W 24Vdc=240W
TL SLC-10-2-ZBT	2 CH 10A TW	10A	12Vdc=120W 24Vdc=240W
TL SLC-10-3-ZBT	3CH 10A (RGB)T	10A	12Vdc=120W 24Vdc=240W
TL SLC-10-5-ZBT	5CH 10A, RGB+CW (RGB+CCT)	10A	12Vdc=120W 24Vdc=240W

SMART MAGTRACK DRIVERS-LONG			
MODEL NO	WATTAGE	CURRENT	VOLTAGE
TL LV-2035-1-ZBT	MAGTRACK - 1CH	(200, 250, 300, 350)mA	(22-40)Vdc
TL LV-3570-1-ZBT	MAGTRACK - 1CH	(200, 250, 300, 350)mA	(22-40)Vdc
TL LV-2035-2-ZBT	MAGTRACK - 2CH	(200, 250, 300, 350)mA	(22-40)Vdc
TL LV-3570-2-ZBT	MAGTRACK - 2CH	(350, 450, 600, 700)mA	(22-40)Vdc

SMART MAGTRACK DRIVERS-MINI			
MODEL NO	WATTAGE	CURRENT	VOLTAGE
TL MT-350-1-ZBT	MINI MAGTRACK 1CH	(150,200,250,300)mA	48V=(20-42)Vdc 24V=(6-20)Vdc
TL MT-350-2-ZBT	MINI MAGTRACK 2CH	(150,200,250,300)mA	48V=(20-42)Vdc 24V=(6-20)Vdc
TL MT-350-1-ZBT	MINI MAGTRACK 1CH	(350, 450, 600, 700)mA	48V=(20-42)Vdc 24V=(6-20)Vdc
TL MT-350-2-ZBT	MINI MAGTRACK 2CH	(350, 450, 600, 700)mA	48V=(20-42)Vdc 24V=(6-20)Vdc



Dimensions (LXWXH) 78mm x 78mm x 25mm
GATEWAY-APPLE HOMEKIT-TL HOMEKIT

ACCESSORIES	PRODUCT	PRODUCT CODE
BLUETOOTH WIRELESS GATEWAY		TL BT GATEWAY
BLUETOOTH & ZIGBEE WIRELESS MULTIMODE GATEWAY		TL MULTI GATEWAY
BLUETOOTH WIRED GATEWAY-L Pro		TL L-PRO GATEWAY
BLUETOOTH WALL REMOTE (3 ZONE)		TL 3 ZONE KEYPAD
BLUETOOTH WALL, REMOTE (4 ZONE) RECHARGBLE BATTERY		TL 4 ZONE REMOTE
BLUETOOTH WHITE HAND REMOTE		TL GANG SWITCH
BLUETOOTH SCENE SWITCH (4 GANG)		TL IR BLASTER
WI-FI IR BLASTER		TL RELAY 10
WI-FI RELAY 10A		TL TW REMOTE
BLUETOOTH BLACK HAND REMOTE		TL SIG REMOTE

T  ISLIGHTS X CAS  AMBI



Dimensions (LXWXH)
123mm X 37mm X 22mm



Dimensions (LXWXH)
145mm x 35mm x 25mm

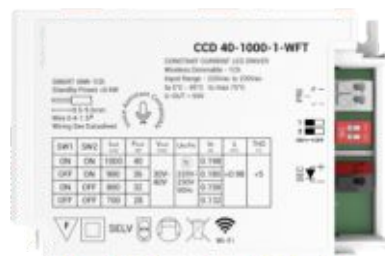

Dimensions (LXWXH)
103.5mm X 67.5mm X 30mm



UWC CASAMBI TRACK LIGHT DRIVER:1CH+2CH

MAGNETIC TRACK DRIVERS FEATURES		
1	Output Type	Constant Current
2	Dimming Type	PWM
3	Dimming Range	0.5% - 100%
4	Dimensions	122.5mm x 14mm x 10mm
INPUT		
5	Rated Input Voltage	48Vdc
6	Operating Input Voltage	24Vdc - 48Vdc
7	Standby Power Consumption	<0.5W
OUTPUT		
8	Output Current	150mA - 700mA (Customised)
9	Output Voltage	For Vin = 48V -> 22V-42V
OUTPUT TYPE		
10	Output Power	Max 30W
11	Constant Current Accuracy	+/- 3%
12	Full Load Output Power	Max 30W
13	Efficiency	>90% @36V
14	Number of Output Channel	1CH and 2CH (select profile)
ENVIRONMENT & PROTECTION		
15	IP Grade	Ip20
16	Insulation Class	Class 2
17	Ambient operating temperature range	5°C - 45°C
18	Storage Temperature	5°C - 45°C
19	Max case temperature	75°C



SMART LIGHTING DRIVERS CASAMBI

MODEL NO	WATTAGE	CURRENT	VOLTAGE
CCD-15-350-1-CSB	6-15W -1CH CSB	(200, 250, 300, 350)mA	(30-42)Vdc
CCD-15-350-2-CSB	6-15W -2CH CSB	(200, 250, 300, 350)mA	(30-42)Vdc
CCD-24-600-1-CSB	6W-24W -1CH CSB	(300, 400, 500, 600)mA	(9-18)Vdc,
CCD-24-600-2-CSB	6W-24W -2CH CSB	(300, 400, 500, 600)mA	(9-18)Vdc
CCD-40-1000-1-CSB	24W-40W ACDC 1CH	(700, 800, 900, 1000)mA	(30-40)Vdc,
CCD-40-1000-2-CSB	24W-40W ACDC 2CH	(700, 800, 900, 1000)mA	(30-40)Vdc,

WIFI CONSTANT VOLTAGE DRIVERS
5A=60W(12V), 120W(24V), 10A=120W(12V), 240W(24V)

MODEL NO	WATTAGE	CURRENT	VOLTAGE
UWC SLC-5-1-CSB	1CH 5A TW	5A	12Vdc=60W 24Vdc=120W
UWC SLC-5-2-CSB	2CH 5A TW	5A	12Vdc=60W 24Vdc=120W
UWC SLC-5-3-CSB	3CH 5A (RGB)	5A	12Vdc=60W 24Vdc=120W
UWC SLC-5-3-CSB	3CH 5A (RGB)	5A	12Vdc=60W 24Vdc=120W

ACCESSORIES	PRODUCT	PRODUCT CODE
SMART IN-TRACK DRIVER		TL SMART TRACK CSB
SMART DALI CONTROLLER		TL DALI CONTROLLER CSB
SMART RELAY		TL RELAT CSB
IR BLASTER		TL IR BLASTER CSB
FREEDOM SWITCH		TL CSB SWITCH-T125585 (GREY/BLACK/WHITE)
SMART KNOB REMOTE CONTRO		TL CSB ROTARY KEYPAD (LG/TG/BS/BC) LIGHT GOLD,TITANIUM GOLD, BRUSHED SS, BRIGHT CHROMIUM
CURTAIN CONTROLLER - Er2508		TL CSB CURTAIN CONTROLLER
KINETIC SWITCH FOR CURTAIN CONTROLLER AND RELAY		TL CSB KINETIC SWITCH-T128495 Dimensions 98mm x 44mm x 31mm
KINETIC SWITCH FOR CURTAIN CONTROLLER AND RELAY		TL CSB KINETIC SWITCH-T128496 Dimensions 98mm x 44mm x 31mm

T  ISLIGHTS X

LTECH
LTECH INTELLIGENT CO., LTD.



T-PWM Dimming technology that achieves dimming down to 0.0001



Magnetic Track Light LED Drivers



Dubai Series Super Smart Knob

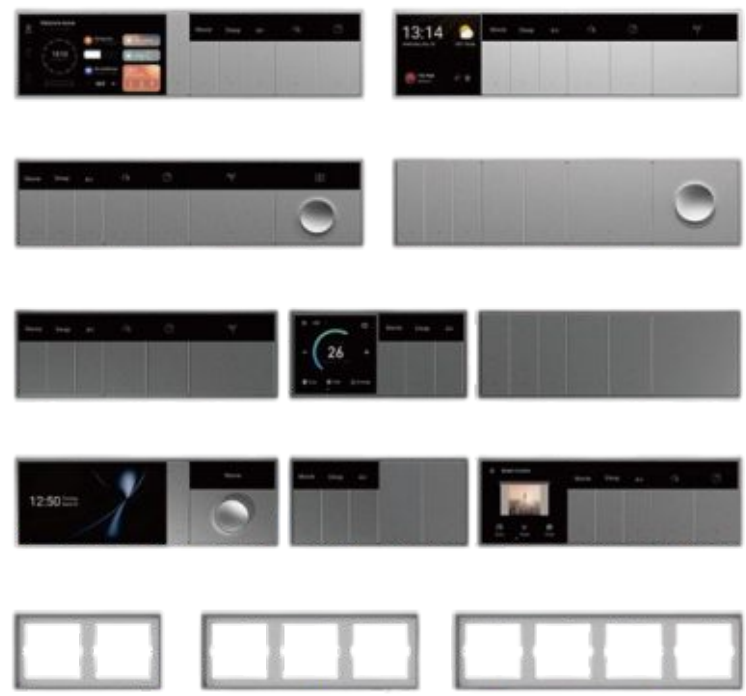

400+ panel combinations



DECODER DMX512

NFC LED Drivers with Soft Start Functionality

Exceptional, high-end soft start effect for LEDs

Lights gradually brighten up from 0.001% that would be more comfortable for human eyes.

Worldwide Certification

CE CB ErP RoHS

L-TECH (SMART ACCESSORIES)

IMAGE	MODEL NO	DESCRIPTION	CURRENT	VOLTAGE
	SP-GW-12S	SUPER PANEL L320XW86XH38mm	100-240Vac 2 Channel load	12V-1.5A C-TYPE
	SP-GW-6S (GREY/GOLD/WHITE)	SUPER PANEL L172XW86XH41mm	100-240Vac 2 Channel load	-
	SP-GW-4S (GREY/GOLD/WHITE)	SUPER PANEL L86XW86XH36.5mm	100-240Vac 2 Channel load	-
	S6-B (GREY/GOLD/WHITE)	ACTIVATED PANEL KEYPAD 6 SWITCH L86XW86XH10.5mm	3Vdc BATTERY WIRELESS	-
	MAGTRACKS DRIVER	4 variants available in Different wattages Suitable in magnetic Light	100-700(SINGLE CHANNEL) 100-650(TWO CHANNEL)	9-42Vdc
	SE-12-100-500-W1B SW-12-100-500-W2B	CONSTANT CURRENT DRIVER NFC ENABLE Dimensions (LxWxH): 111x35x20mm	12W@100-500mA 20W@100-700mA 1/2-CHANNEL	9-42Vdc
	SE-20-100-700-W1B SE-20-100-700-W2B	CONSTANT CURRENT DRIVER NFC ENABLE Dimensions (LxWxH): 127x40x23mm	12W@100-500mA 20W@100-700mA 1/2-CHANNEL	9-42Vdc
	SE-30-200-800-W1B SE-30-200-800-W2B	CONSTANT CURRENT DRIVER NFC ENABLE Dimensions (LxWxH): 142x40x23mm	30W @ 200-800mA 1/2 CHANNEL	9-42Vdc
	SE-40-300-1050-W2B SE-40-300-1050-W2B	CONSTANT CURRENT DRIVER NFC ENABLE Dimensions (LxWxH): 142x40x23mm	40W@300-1050mA 1/2 CHANNEL	9-42Vdc
	SE-20-50-100-W5B (RGBWW)	CONSTANT CURRENT DRIVER NFC ENABLE Dimensions (LxWxH): 127x40x23mm	20W RGBW INTELLIGENT	9-42Vdc
	LM-36-24-G1B LM-36-24-G2B	CONSTANT CURRENT DRIVER NFC ENABLE Product size: L210xW43xH30mm	36W-1 CHANNEL 36W-2 CHANNEL	24Vdc
	LM-75-24-G1B2 LM-75-24-G2B2	CONSTANT CURRENT DRIVER NFC ENABLE Dimensions (LxWxH): 293x43x30mm	75W-1 CHANNEL 75W-2 CHANNEL	24Vdc
	LM-150-24-G1B2 LM-150-24-G2B2	CONSTANT CURRENT DRIVER NFC ENABLE Dimensions (LxWxH): 352x43x30mm	150W-1 CHANNEL 150W-2 CHANNEL	24Vdc
	LM-240-24-G1B LM-240-24-G2B	CONSTANT CURRENT DRIVER NFC ENABLE Product size: L380xW49.5xH30mm	240W-1 CHANNEL 240W-2 CHANNEL	24Vdc
	HAM-BLE	IR SMART CONTROL Dia. 109mm X H25mm	RF Rate : 433MHz IR Rate : 38KHz	24Vdc
	CS-AIR-PRO	CENTRAL AIR CONDITIONING (HVAC) Dimensions (LxWxH): 105*87*58mm	-	INPUT 12Vdc LINE VOLTAGE : AC 5V
	CG-KIT	APPLE HOME KIT	-	-
	HS-BLE	MOTION SENSOR 4.2M Range SURFACE Dimensions (LxWxH): 90*90*36mm	-	3Vdc
	RC4-BLE	INTELLIGENT REMOTE Dimensions (LxWxH): 40x150x13mm	-	3Vdc
	CG-TRIG	THIRD PARTY CURTAIN MOTOR CONTROL 4channel (LxWxH): 48x28x14mm	-	12/24Vdc
	RELAY-BLE01	RELAY SWITCH BLUETOOTH Dimensions (LxWxH): 80x35x23mm	-	100-240Vac
	CG-T (TRIAC)	TRIAC MODULE INTEGRATION Dimensions (LxWxH): 52x59x20mm	-	100-240Vac
	CG-D-PRO (DALI)	THIRD PARTY INTEGRATION (DALI MASTER WITH BUS POWER SUPPLY)	-	24Vdc INPUT

APPLICATIONS: Downlight, Home, Off ice

AREAS OF APPLICATIONS: Home, Off ice

FEATURES: App Control, Zigbee, Bluetooth Mesh, Google Assistant, Amazon Alexa, Tunable White, Dimming

